

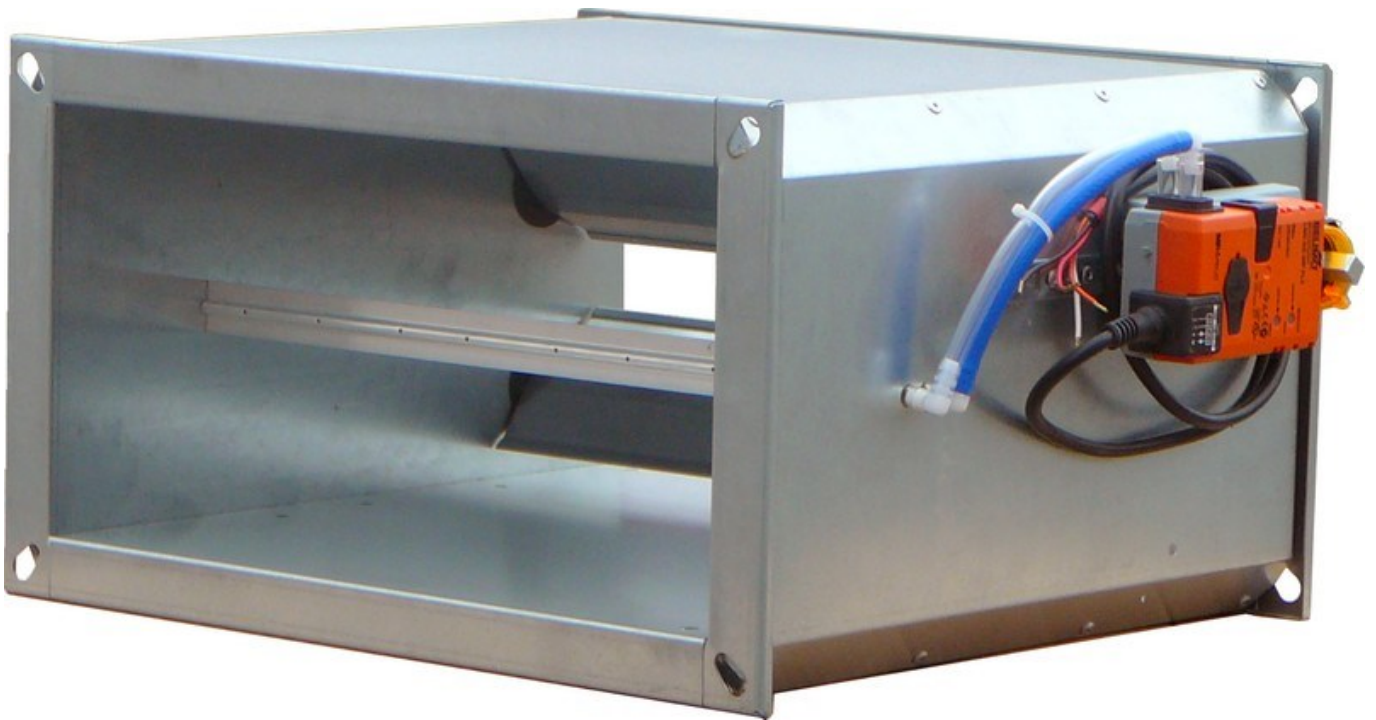

airconcepts

Airflow Measurement & Control Products



VSQ

Rechthoekige VAV units

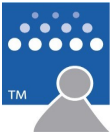

Toepassing

VAV units worden toegepast in airconditionings- en ventilatie systemen om het comfort te verbeteren en het energie verbruik te verlagen.

De VAV unit wordt gestuurd door een thermostaat of DDC regelaar en varieert de luchthoeveelheid op basis van koelbehoefte en/of ventilatiebehoefte. Dit levert een aanzienlijke besparing op in ventilatorenergie omdat bij weinig of geen koelvraag de klep deels of zelfs geheel gesloten kan worden.

De VAV unit kan ook bij luchtkwaliteit regeling worden toegepast. Afhankelijk van de CO₂ concentratie wordt er dan meer of minder verse lucht toegevoerd.

De units zijn verkrijgbaar in enkel- en dubbelwandige uitvoering.

Constructie

Unit

- Behuizing; gegalvaniseerd staal (275 g/m²), luchtdicht volgens klasse "B" NEN-EN-1507 en NEN-EN-12237. Klasse C op aanvraag mogelijk.
- Flens: 30mm, voorzien van sleufgaten ø8x21mm passend op kanaalprofiel van 20-30mm.
- Klepblad standaard uitvoering: geprofileerd gegalvaniseerd staal.
- Lagers + tandwielen: ABS
- Klepas: aluminium 10x10 mm (ø12 op aanvraag)
- Bedrijftemperatuur +5°C tot +50°C
- Opslagtemperatuur -5°C tot +70°C

FloXact™ Luchtsnelheidsensor

- 2% nauwkeurigheid
- Geëxtrudeerd aluminium meetprofiel.
- Gemiddelde meting over meerdere meetpunten.
- Versterking van meetsignaal met minimaal 2.5x.
- Nauwkeurige meting vanaf 1.0m/s luchtsnelheid
- Afgeronde meetopeningen maken de FloXact™ ongevoelig voor scheve of turbulente aanstroming tot 30° in alle richtingen t.o.v. de profiel as.

Regeling

- De units worden geleverd compleet met fabrieksmatig gekalibreerde regelaars
- Alle VAV units kunnen worden geleverd met analoge, DDC of pneumatische regelaars.
- Montage van gratis toegeleverde regelapparatuur mogelijk in overleg.
- Alle regelapparatuur wordt standaard aan de rechterzijde (gezien met luchtrichting mee) van de unit gemonteerd tenzij bij bestelling anders vermeld.

Optioneel

- Luchtdichte uitvoering (klasse 2) met geëxtrudeerd aluminium klepbladen met rubber strip en zijprofiel.
- Warmwater naverwarmingsbatterij 1-, 2-, of 4-rij.



Type VSQ-SW-BE1 (enkelwandig met Belimo LMV-D3-MP)

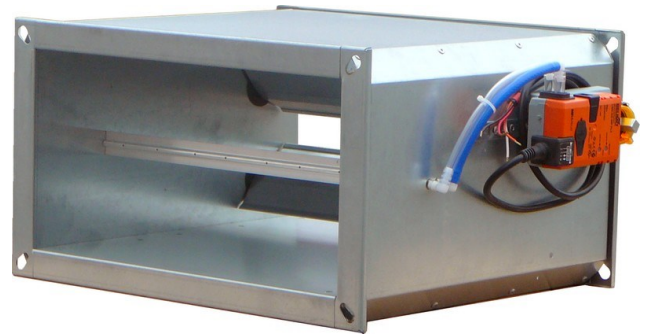

Type VSQ-DW-BE1 (dubbelwandig met Belimo LMV-D3-MP)

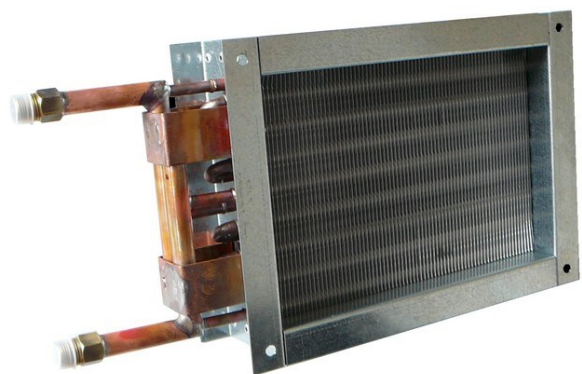

Type HWQ warmwater naverwarmingsbatterij (optioneel)

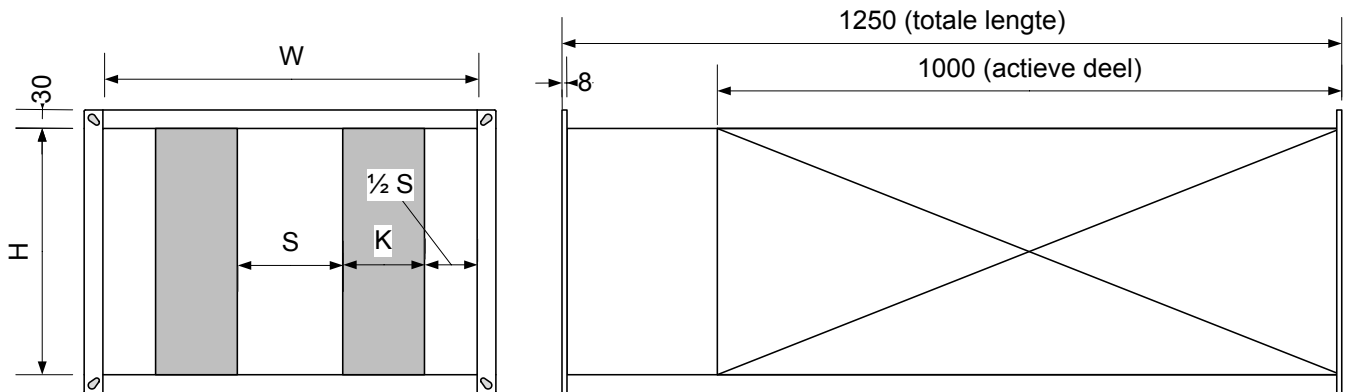
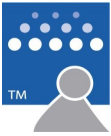

Statische demping geluiddemper type SA

W	K	n° K	S	VD %	125	250	500	1K	2K	4K
200	100	1	100	50%	3	9	23	38	36	22
250	100	1	150	60%	2	7	16	26	21	13
300	150	1	150	50%	3	10	21	31	28	16
350	150	1	200	57%	3	8	13	23	20	12
400	150	1	250	63%	2	6	9	17	15	9
450	200	1	250	56%	4	8	11	18	17	9
500	200	1	300	60%	4	7	8	15	15	8
550	200	1	350	64%	3	6	6	13	14	7
600	150	2	150	50%	3	10	21	31	28	16
650	150	2	175	54%	3	9	17	27	24	14
700	150	2	200	57%	3	8	13	23	20	12
750	150	2	225	60%	3	7	11	20	18	10
800	200	2	200	50%	4	10	17	23	21	11
850	200	2	225	53%	4	9	14	20	18	10
900	200	2	250	56%	4	8	11	18	17	9
950	200	2	275	58%	4	8	10	16	15	8
1000	200	2	300	60%	4	7	8	15	15	8
1050	200	2	325	62%	4	6	7	14	14	7
1100	200	2	350	64%	3	6	6	13	14	7
1150	200	2	375	65%	3	6	5	12	14	6

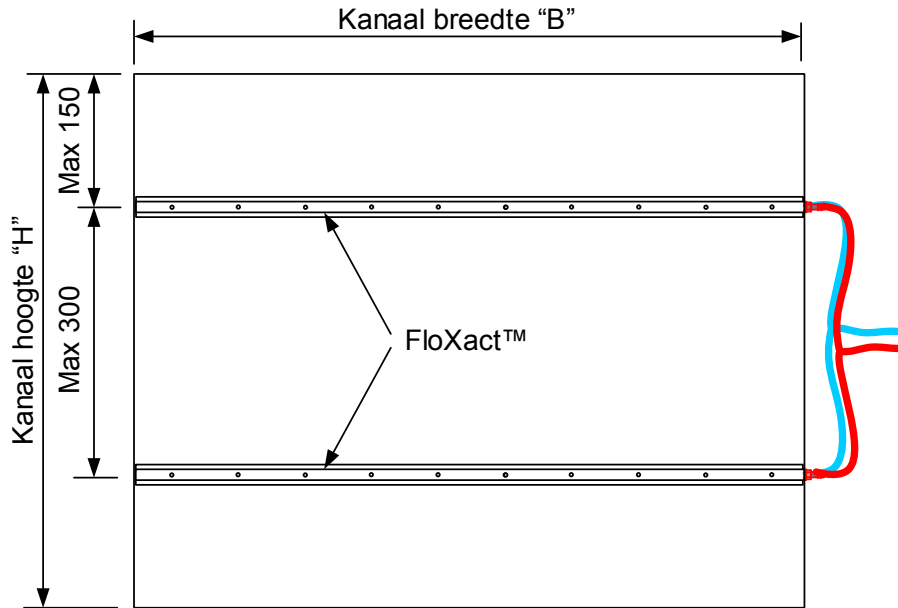
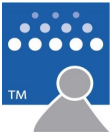

Kanaal "H"	aantal FloXact™	Kanaal breedte "B"													
		200	250	300	350	400	450	500	600	700	800	900	1000	1100	1200
		K _v waarde in l/s/Pa													
150	1	23,0	28,8	34,5	40,3	46,0	51,8	57,5	69,1	80,6	92,1	104	115	127	138
200		33,1	41,4	49,7	58,0	66,3	74,6	82,9	99,4	116	133	149	166	182	199
250		41,4	51,8	62,1	72,5	82,9	93,2	104	124	145	166	186	207	228	249
300		47,0	58,7	70,4	82,2	94	106	117	141	164	188	211	235	258	282
350	2	55,2	69,1	82,9	96,7	110	124	138	166	193	221	249	276	304	331
400		65,4	81,7	98,1	114	131	147	163	196	229	261	294	327	360	392
450		73,7	92,1	110	129	147	166	184	221	258	295	331	368	405	442
500		83,8	105	126	147	168	189	209	251	293	335	377	419	461	503
600	3	101	127	152	177	203	228	253	304	354	405	456	506	557	608
700		115	144	173	201	230	259	288	345	403	460	518	575	633	691
800		133	167	200	234	267	300	334	400	467	534	601	667	734	801
900	4	152	190	228	266	304	342	380	456	532	608	684	760	836	911
1000		166	207	249	290	331	373	414	497	580	663	746	829	911	994
1100		184	230	276	322	368	414	460	552	644	737	829	921	1013	1105
1200		203	253	304	354	405	456	506	608	709	810	911	1013	1114	1215

- Op basis van de K_v waarde kan het luchtvolume worden berekend met onderstaande formule:

$$Q = K_v \cdot 3,6 \cdot \sqrt{P_{fs}}$$

Q = luchtvolume in m³/h

K_v = K_v waarde in l/s/Pa

P_{fs} = drukverschil gemeten op de FloXact™ in Pa

- Bovenstaande tabel is gebaseerd op een luchtdichtheid van 1.20 kg/m³ (lucht van 20°C, 50% r.v. en 1013 mbar). De correctie voor andere luchtdichtheden kan met onderstaande formule berekend worden:

$$Corr = \sqrt{(\rho/1.20)}$$

- Voor afwijkende afmetingen of selecties kunt u contact opnemen met onze technisch adviseurs.

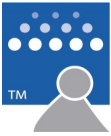

Geluiddata

1. Voor de snelselectie voor **luchtgeluid** (LpA) is een ruimtedemping aangehouden van 5dB per Oktaafband en een kanaaldemping en eindreflectie van :

125	250	500	1k	2k	4k	Hz
-5	-3	-2	-3	-3	-3	dB

2. Voor de snelselectie voor **luchtgeluid** (LpA) is tevens rekening gehouden met geluiddemping van het secundaire kanaalsysteem inclusief roosters en slangen. Deze demping (K1) is afhankelijk van de luchthoeveelheid. Zie tabel K1.
3. Voor de snelselectie voor **afgestraald geluid** (LpA) is een ruimtedemping van 5dB per Octaafband en 4dB per Octaafband plafonddemping verdisconteerd.
4. De geluidmetingen zijn uitgevoerd conform de richtlijnen in standaards ISO 3741 en ISO 5135.
5. Geluidvermogen Lw in dB per Octaafband zijn conform re 10^{-12} Watt. Waarden onder 17 dB zijn als "-" weergegeven.
6. Het A gewogen geluidvermogen Lw(A) in dB per Octaafband zijn conform re 10^{-12} Watt. Waarden onder 20 dB(A) zijn als "-" weergegeven.
7. **n/a** de geselecteerde drukval is lager dan de minimaal benodigde druk (min ΔPs) om de unit correct te laten functioneren.
8. **Ps** Statischedruk.
9. **Pt** Totaaldruk.
10. **min ΔPs**. Minimale drukverschil bij volledig geopende klep en luchthoeveelheid zoals in tabel weergegeven.

Tabel K1: Correctie demping secundair kanaal

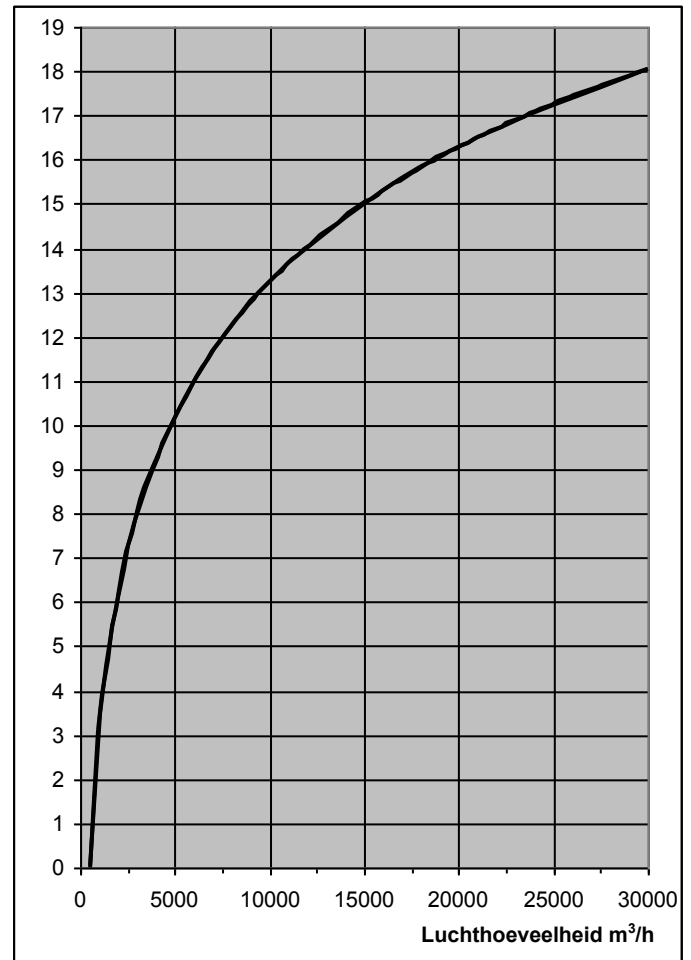

Correctie geluidselectie overige afmetingen

Op pagina's 6 t/m 11 is de geluidselectie vermeld van een aantal afmetingen. Voor niet vermelde afmetingen kan met de correctie factor uit onderstaande tabel de geluidsproductie worden bepaald. De correctiefactor is gegeven t.o.v. de in de tabel vermelde afmeting 500x400mm

Unit oppervlakte B x H (m²)	0,04	0,06	0,08	0,1	0,15	0,2	0,3	0,4	0,6	0,8	1	1,2	1,4
Correctie (dB)	-7	-5	-3	-2	-1	0	+1	+2	+3	+4	+4	+5	+6

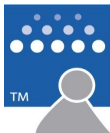

Drukval over unit : 100Pa

Unit afmeting equivalente diameter	Lucht volume (m ³ /h)	Luchtsnelheid (m/s)	Min. P _{st} (Pa)	snelselectie L _p (A) in dB(A)			Luchtgeluid VSQ-SW + VSQ-DW							Afgestraald geluid VSQ-SW						Afgestraald geluid VSQ-DW							
				Luchtgeluid	Afgestraald geluid enkelwandig	Afgestraald geluid dubbelwandig	Lw (dB/oct) re 10 ⁻¹² W							Lw (dB/oct) re 10 ⁻¹² W													
							125 Hz	250 Hz	500 Hz	1000 Hz	2000 Hz	4000 Hz	L _w (A) dB(A)	125 Hz	250 Hz	500 Hz	1000 Hz	2000 Hz	4000 Hz	L _w (A) dB(A)	125 Hz	250 Hz	500 Hz	1000 Hz	2000 Hz	4000 Hz	L _w (A) dB(A)
300x300 (eq. ø355)	486	1,5	1	28	--	--	41	41	35	18	22	-	45	27	25	18	-	-	-	29	23	21	-	-	-	-	25
	1296	4,0	5	43	30	26	56	59	55	44	43	36	62	42	43	38	30	27	28	47	38	39	34	26	23	22	43
	1944	6,0	12	41	30	26	56	59	53	44	44	37	61	42	43	36	30	28	29	46	38	39	32	26	24	23	42
	2592	8,0	21	38	29	25	55	58	52	43	44	37	60	41	42	35	29	28	29	45	37	38	31	25	24	23	41
	3350	10,3	35	39	31	27	60	58	52	44	48	41	63	46	42	35	30	32	33	48	42	38	31	26	28	27	44
400x300 (eq. ø400)	632	1,5	1	28	--	--	42	42	36	19	23	-	46	28	26	19	-	-	-	31	24	22	-	-	-	-	27
	1728	4,0	5	43	32	27	57	60	56	45	44	37	63	43	44	39	31	28	29	48	39	40	35	27	24	23	44
	2592	6,0	12	41	31	27	57	60	55	45	45	39	63	43	44	38	31	29	31	47	39	40	34	27	25	25	43
	3456	8,0	21	38	30	26	56	59	53	44	45	38	62	42	43	36	30	29	30	46	38	39	32	26	25	24	42
	4467	10,3	35	39	33	28	61	60	53	45	50	43	64	47	44	36	31	34	35	49	43	40	32	27	30	29	45
400x400 (eq. ø450)	804	1,4	1	28	--	--	43	43	37	19	23	-	46	29	27	20	-	-	-	31	25	23	-	-	-	-	27
	2304	4,0	5	43	33	29	59	61	58	46	46	38	64	45	45	41	32	30	30	49	41	41	37	28	26	24	45
	3456	6,0	12	41	32	28	58	61	56	46	46	40	64	44	45	39	32	30	32	48	40	41	35	28	26	26	44
	4608	8,0	21	38	32	27	57	60	54	46	46	40	63	43	44	37	32	30	32	48	39	40	33	28	26	26	44
	5685	9,9	32	38	33	29	61	61	54	46	50	43	65	47	45	37	32	34	35	50	43	41	33	28	30	29	46
500x400 (eq. ø500)	1005	1,4	1	28	--	--	45	45	38	20	24	-	48	31	29	21	-	-	-	33	27	25	17	-	-	-	29
	2880	4,0	5	44	34	30	61	63	59	47	47	39	66	47	47	42	33	31	31	51	43	43	38	29	27	25	47
	4320	6,0	12	41	34	30	60	63	57	47	47	41	66	46	47	40	33	31	33	50	42	43	36	29	27	27	46
	5760	8,0	21	39	33	29	59	62	56	47	47	41	65	45	46	39	33	31	33	49	41	42	35	29	27	27	45
	7106	9,9	32	39	35	30	63	62	56	47	51	44	66	49	46	39	33	35	36	52	45	42	35	29	31	30	48
600x400 (eq. ø560)	1206	1,4	1	29	--	--	46	46	39	21	25	-	50	32	30	22	-	-	-	35	28	26	18	-	-	-	31
	3456	4,0	5	44	36	32	62	65	60	48	47	40	68	48	49	43	34	31	32	52	44	45	39	30	27	26	48
	5184	6,0	12	42	35	31	62	65	59	48	48	42	67	48	49	42	34	32	34	52	44	45	38	30	28	28	48
	6912	8,0	21	39	34	30	61	64	57	47	48	41	66	47	48	40	33	32	33	51	43	44	36	29	28	27	47
	8528	9,9	32	39	36	31	65	64	57	48	52	45	68	51	48	40	34	36	37	53	47	44	36	30	32	31	49
800x400 (eq. ø630)	1608	1,4	1	30	--	--	49	49	41	22	26	18	52	35	33	24	-	-	-	37	31	29	20	-	-	-	33
	4608	4,0	5	45	38	34	65	67	62	49	49	41	70	51	51	45	35	33	33	55	47	47	41	31	29	27	51
	6912	6,0	12	43	37	33	64	67	61	49	49	43	70	50	51	44	35	33	35	54	46	47	40	31	29	29	50
	9216	8,0	21	40	36	32	63	66	59	49	49	43	69	49	50	42	35	33	35	53	45	46	38	31	29	29	49
	11370	9,9	32	40	38	33	67	67	59	49	53	46	70	53	51	42	35	37	38	56	49	47	38	31	33	32	51
1000x400 (eq. ø710)	2010	1,4	1	31	20	--	51	51	43	23	27	19	54	37	35	26	-	-	-	39	33	31	22	-	-	-	35
	5760	4,0	5	46	39	35	67	69	64	50	50	42	72	53	53	47	36	34	34	57	49	49	43	32	30	28	53
	8640	6,0	12	43	39	35	66	69	62	50	50	44	71	52	53	45	36	34	36	56	48	49	41	32	30	30	52
	11520	8,0	21	41	38	34	65	68	61	50	50	44	71	51	52	44	36	34	36	55	47	48	40	32	30	30	51
	14213	9,9	32	41	39	35	69	69	60	50	54	47	72	55	53	43	36	38	39	57	51	49	39	32	34	33	53
1000x500 (eq. ø800)	2584	1,4	1	32	22	--	53	53	45	25	29	21	56	39	37	28	-	-	-	41	35	33	24	-	-	-	37
	7200	4,0	5	47	41	37	69	71	65	51	51	43	74	55	55	48	37	35	35	59	51	51	44	33	31	29	55
	10800	6,0	12	44	40	36	68	71	64	51	51	45	73	54	55	47	37	35	37	58	50	51	43	33	31	31	54
	14400	8,0	21	42	39	35	67	70	62	51	51	45	72	53	54	45	37	35	37	57	49	50	41	33	31	31	53
	18273	10,2	34	41	41	37	72	71	62	52	55	49	75	58	55	45	38	39	41	60	54	51	41	34	35	35	56

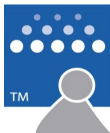

Drukval over unit : 200Pa

Unit afmeting equivalente diameter	Lucht volume (m ³ /h)	Luchtsnelheid (m/s)	Min. P _{st} (Pa)	snelselectie			Luchtgeluid VSQ-SW + VSQ-DW							Afgestraald geluid VSQ-SW					Afgestraald geluid VSQ-DW								
				L _p (A) in dB(A)			Lw (dB/oct) re 10 ⁻¹² W							Lw (dB/oct) re 10 ⁻¹² W					Lw (dB/oct) re 10 ⁻¹² W								
				Luchtgeluid	Afgestraald geluid enkelwandig	Afgestraald geluid dubbelwandig	125 Hz	250 Hz	500 Hz	1000 Hz	2000 Hz	4000 Hz	Lw(A) dB(A)	125 Hz	250 Hz	500 Hz	1000 Hz	2000 Hz	4000 Hz	Lw(A) dB(A)	125 Hz	250 Hz	500 Hz	1000 Hz	2000 Hz	4000 Hz	Lw(A) dB(A)
300x300 (eq. ø355)	486	1,5	1	26	--	--	40	39	32	-	19	-	43	26	23	-	-	-	-	28	22	19	-	-	-	-	24
	1296	4,0	5	46	33	28	58	61	58	47	45	38	64	44	45	41	33	29	30	48	40	41	37	29	25	24	44
	1944	6,0	12	53	42	38	65	69	67	59	55	48	73	51	53	50	45	39	40	57	47	49	46	41	35	34	53
	2592	8,0	21	50	41	36	64	68	65	57	54	48	71	50	52	48	43	38	40	55	46	48	44	39	34	34	51
	3350	10,3	35	48	40	35	63	67	62	56	54	48	70	49	51	45	42	38	40	54	45	47	41	38	34	34	50
400x300 (eq. ø400)	632	1,5	1	26	--	--	40	40	33	-	20	-	43	26	24	-	-	-	-	28	22	20	-	-	-	-	24
	1728	4,0	5	46	34	30	59	62	59	48	47	39	65	45	46	42	34	31	31	50	41	42	38	30	27	25	46
	2592	6,0	12	53	44	39	66	71	68	60	57	49	74	52	55	51	46	41	41	58	48	51	47	42	37	35	54
	3456	8,0	21	50	42	38	65	69	66	59	56	49	72	51	53	49	45	40	41	57	47	49	45	41	36	35	53
	4467	10,3	35	48	41	37	64	68	64	57	55	49	71	50	52	47	43	39	41	55	46	48	43	39	35	35	51
400x400 (eq. ø450)	804	1,4	1	50	34	30	59	62	60	45	43	34	65	45	46	43	31	27	26	50	41	42	39	27	23	20	46
	2304	4,0	5	46	35	31	60	63	60	49	48	40	66	46	47	43	35	32	32	51	42	43	39	31	28	26	47
	3456	6,0	12	53	45	41	68	72	70	61	58	51	75	54	56	53	47	42	43	59	50	52	49	43	38	37	55
	4608	8,0	21	50	43	39	66	70	67	60	57	50	73	52	54	50	46	41	42	58	48	50	46	42	37	36	54
	5685	9,9	32	48	42	38	65	69	65	59	57	50	72	51	53	48	45	41	42	57	47	49	44	41	37	36	53
500x400 (eq. ø500)	1005	1,4	1	50	35	31	61	63	62	46	44	35	67	47	47	45	32	28	27	51	43	43	41	28	24	21	47
	2880	4,0	5	46	37	32	62	65	62	50	49	41	68	48	49	45	36	33	33	53	44	45	41	32	29	27	49
	4320	6,0	12	54	46	42	70	74	71	62	59	52	77	56	58	54	48	43	44	61	52	54	50	44	39	38	57
	5760	8,0	21	51	45	40	68	72	69	61	58	51	75	54	56	52	47	42	43	60	50	52	48	43	38	37	56
	7106	9,9	32	49	44	39	67	71	67	60	57	51	74	53	55	50	46	41	43	59	49	51	46	42	37	37	55
600x400 (eq. ø560)	1206	1,4	1	51	37	33	63	65	63	47	45	36	69	49	49	46	33	29	28	53	45	45	42	29	25	22	49
	3456	4,0	5	47	38	34	64	67	63	51	50	42	70	50	51	46	37	34	34	54	46	47	42	33	30	28	50
	5184	6,0	12	54	47	43	71	75	72	63	60	52	78	57	59	55	49	44	44	63	53	55	51	45	40	38	59
	6912	8,0	21	51	46	42	70	74	70	62	59	52	77	56	58	53	48	43	44	61	52	54	49	44	39	38	57
	8528	9,9	32	49	45	41	69	73	68	61	58	52	76	55	57	51	47	42	44	60	51	53	47	43	38	38	56
800x400 (eq. ø630)	1608	1,4	1	52	39	35	65	68	65	48	46	37	71	51	52	48	34	30	29	55	47	48	44	30	26	23	51
	4608	4,0	5	48	40	36	66	69	65	52	51	43	72	52	53	48	38	35	35	57	48	49	44	34	31	29	53
	6912	6,0	12	55	49	45	74	78	74	64	61	54	81	60	62	57	50	45	46	65	56	58	53	46	41	40	61
	9216	8,0	21	52	48	44	72	76	72	63	60	53	79	58	60	55	49	44	45	63	54	56	51	45	40	39	59
	11370	9,9	32	50	47	42	71	75	70	62	60	53	78	57	59	53	48	44	45	62	53	55	49	44	40	39	58
1000x400 (eq. ø710)	2010	1,4	1	52	40	36	67	69	67	49	47	38	73	53	53	50	35	31	30	57	49	49	46	31	27	24	53
	5760	4,0	5	48	42	37	68	71	66	53	52	44	74	54	55	49	39	36	36	59	50	51	45	35	32	30	55
	8640	6,0	12	56	51	47	76	80	76	65	62	55	82	62	64	59	51	46	47	67	58	60	55	47	42	41	63
	11520	8,0	21	52	49	45	74	78	73	64	61	54	81	60	62	56	50	45	46	65	56	58	52	46	41	40	61
	14213	9,9	32	50	48	44	73	77	72	63	60	54	80	59	61	55	49	44	46	64	55	57	51	45	40	40	60
1000x500 (eq. ø800)	2584	1,4	1	54	43	39	70	72	69	51	49	40	75	56	56	52	37	33	32	60	52	52	48	33	29	26	56
	7200	4,0	5	49	43	39	70	73	68	54	53	45	76	56	57	51	40	37	37	60	52	53	47	36	33	31	56
	10800	6,0	12	56	53	48	78	82	78	66	63	56	84	64	66	61	52	47	48	69	60	62	57	48	43	42	65
	14400	8,0	21	53	51	47	76	80	75	65	62	55	83	62	64	58	51	46	47	67	58	60	54	47	42	41	63
	18273	10,2	34	51	50	45	75	79	73	64	61	55	81	61	63	56	50	45	47	66	57	59	52	46	41	41	62

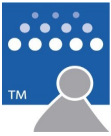

Drukval over unit : 400Pa

Unit afmeting equivalente diameter	Lucht volume (m ³ /h)	Luchtsnelheid (m/s)	Min. P _{st} (Pa)	snelselectie			Luchtgeluid VSQ-SW + VSQ-DW						Afgestraald geluid VSQ-SW					Afgestraald geluid VSQ-DW									
				L _p (A) in dB(A)			Lw (dB/oct) re 10 ⁻¹² W						Lw (dB/oct) re 10 ⁻¹² W					Lw (dB/oct) re 10 ⁻¹² W									
				Luchtgeluid	Afgestraald geluid enkelwandig	Afgestraald geluid dubbelwandig	125 Hz	250 Hz	500 Hz	1000 Hz	2000 Hz	4000 Hz	L _w (A) dB(A)	125 Hz	250 Hz	500 Hz	1000 Hz	2000 Hz	4000 Hz	L _w (A) dB(A)	125 Hz	250 Hz	500 Hz	1000 Hz	2000 Hz	4000 Hz	L _w (A) dB(A)
300x300 (eq. ø355)	486	1,5	1	54	36	32	60	63	63	48	45	36	67	46	47	46	34	29	28	51	42	43	42	30	25	22	47
	1296	4,0	5	49	36	32	61	64	61	51	49	41	67	47	48	44	37	33	33	52	43	44	40	33	29	27	48
	1944	6,0	12	56	44	40	67	71	69	61	57	50	74	53	55	52	47	41	42	59	49	51	48	43	37	36	55
	2592	8,0	21	61	52	48	72	77	76	70	64	57	81	58	61	59	56	48	49	65	54	57	55	52	44	43	61
	3350	10,3	35	60	52	48	72	77	76	71	65	58	81	58	61	59	57	49	50	65	54	57	55	53	45	44	61
400x300 (eq. ø400)	632	1,5	1	54	37	33	61	64	64	50	46	37	68	47	48	47	36	30	29	53	43	44	43	32	26	23	49
	1728	4,0	5	49	37	33	62	65	63	52	50	42	68	48	49	46	38	34	34	53	44	45	42	34	30	28	49
	2592	6,0	12	56	46	42	68	72	71	63	58	51	76	54	56	54	49	42	43	60	50	52	50	45	38	37	56
	3456	8,0	21	61	53	49	73	78	77	71	66	58	82	59	62	60	57	50	50	66	55	58	56	53	46	44	62
	4467	10,3	35	60	53	49	73	78	77	72	66	60	82	59	62	60	58	50	52	66	55	58	56	54	46	46	62
400x400 (eq. ø450)	804	1,4	1	55	39	35	63	66	66	51	48	38	70	49	50	49	37	32	30	54	45	46	45	33	28	24	50
	2304	4,0	5	49	39	35	63	67	64	54	51	44	70	49	51	47	40	35	36	54	45	47	43	36	31	30	50
	3456	6,0	12	56	47	43	69	74	72	64	60	52	77	55	58	55	50	44	44	61	51	54	51	46	40	38	57
	4608	8,0	21	61	54	50	74	80	79	73	67	60	83	60	64	62	59	51	52	68	56	60	58	55	47	46	64
	5685	9,9	32	60	54	50	74	80	78	73	67	61	83	60	64	61	59	51	53	68	56	60	57	55	47	47	64
500x400 (eq. ø500)	1005	1,4	1	55	40	36	65	68	67	52	49	39	72	51	52	50	38	33	31	56	47	48	46	34	29	25	52
	2880	4,0	5	50	40	36	65	68	66	55	52	44	72	51	52	49	41	36	36	56	47	48	45	37	32	30	52
	4320	6,0	12	56	48	44	71	75	73	65	61	53	79	57	59	56	51	45	45	63	53	55	52	47	41	39	59
	5760	8,0	21	62	56	51	76	81	80	74	68	61	85	62	65	63	60	52	53	69	58	61	59	56	48	47	65
	7106	9,9	32	61	56	52	76	82	80	74	68	62	85	62	66	63	60	52	54	69	58	62	59	56	48	48	65
600x400 (eq. ø560)	1206	1,4	1	56	42	38	66	69	69	53	49	40	73	52	53	52	39	33	32	57	48	49	48	35	29	26	53
	3456	4,0	5	50	41	37	67	70	67	55	53	45	73	53	54	50	41	37	37	57	49	50	46	37	33	31	53
	5184	6,0	12	57	50	45	73	77	75	66	61	54	80	59	61	58	52	45	46	64	55	57	54	48	41	40	60
	6912	8,0	21	62	57	53	78	83	81	74	69	61	86	64	67	64	60	53	53	71	60	63	60	56	49	47	67
	8528	9,9	32	61	57	53	78	83	81	75	69	62	86	64	67	64	61	53	54	71	60	63	60	57	49	48	67
800x400 (eq. ø630)	1608	1,4	1	57	44	40	69	72	71	54	51	41	75	55	56	54	40	35	33	60	51	52	50	36	31	27	56
	4608	4,0	5	51	44	39	69	73	69	57	54	47	75	55	57	52	43	38	39	60	51	53	48	39	34	33	56
	6912	6,0	12	57	51	47	75	80	77	67	63	55	82	61	64	60	53	47	47	67	57	60	56	49	43	41	63
	9216	8,0	21	63	58	54	80	86	83	76	70	63	89	66	70	66	62	54	55	73	62	66	62	58	50	49	69
	11370	9,9	32	62	59	55	80	86	83	76	71	64	89	66	70	66	62	55	56	73	62	66	62	58	51	50	69
1000x400 (eq. ø710)	2010	1,4	1	57	45	41	71	74	72	55	52	42	77	57	58	55	41	36	34	61	53	54	51	37	32	28	57
	5760	4,0	5	52	45	41	71	74	70	58	55	48	77	57	58	53	44	39	40	62	53	54	49	40	35	34	58
	8640	6,0	12	58	53	49	77	81	78	68	64	56	84	63	65	61	54	48	48	69	59	61	57	50	44	42	65
	11520	8,0	21	63	60	56	82	87	85	77	71	64	90	68	71	68	63	55	56	75	64	67	64	59	51	50	71
	14213	9,9	32	62	60	56	82	88	85	77	71	65	90	68	72	68	63	55	57	75	64	68	64	59	51	51	71
1000x500 (eq. ø800)	2584	1,4	1	58	47	43	72	75	73	56	53	43	79	58	59	56	42	37	35	63	54	55	52	38	33	29	59
	7200	4,0	5	53	47	43	73	76	72	59	56	48	79	59	60	55	45	40	40	64	55	56	51	41	36	34	60
	10800	6,0	12	58	55	50	79	83	80	69	65	57	86	65	67	63	55	49	49	70	61	63	59	51	45	43	66
	14400	8,0	21	64	61	57	84	89	87	78	72	64	92	70	73	70	64	56	56	76	66	69	66	60	52	50	72
	18273	10,2	34	63	62	57	84	90	86	78	73	66	92	70	74	69	64	57	58	77	66	70	65	60	53	52	73

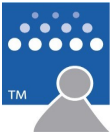

Drukval over unit : 100Pa

Unit afmeting equivalente diameter	Lucht volume (m ³ /h)	Luchtsnelheid (m/s)	Min. P _{st} (Pa)	snelselectie			Luchtgeluid VSQ-SW(DW)-SA							Afgestraald geluid VSQ-SW-SA					Afgestraald geluid VSQ-DW-SA									
				L _p (A) in dB(A)			Lw (dB/oct) re 10 ⁻¹² W							Lw (dB/oct) re 10 ⁻¹² W					Lw (dB/oct) re 10 ⁻¹² W									
				Luchtgeluid	Afgestraald geluid enkelwandig	Afgestraald geluid dubbelwandig	125 Hz	250 Hz	500 Hz	1000 Hz	2000 Hz	4000 Hz	L _w (A) dB(A)	125 Hz	250 Hz	500 Hz	1000 Hz	2000 Hz	4000 Hz	L _w (A) dB(A)	125 Hz	250 Hz	500 Hz	1000 Hz	2000 Hz	4000 Hz	L _w (A) dB(A)	
300x300 (eq. ø355)	486	1,5	2	--	--	--	38	31	-	-	-	-	-	-	38	27	25	18	-	-	-	29	23	21	-	-	-	25
	1296	4,0	17	31	30	26	53	49	38	32	29	25	55	42	43	38	30	27	28	28	47	38	39	34	26	23	22	43
	1944	6,0	38	35	30	26	53	51	46	43	40	35	56	42	43	36	30	28	29	29	46	38	39	32	26	24	23	42
	2592	8,0	66	41	29	25	56	55	53	50	47	42	61	41	42	35	29	28	29	29	45	37	38	31	25	24	23	41
	3350	10,3	108	n/a	n/a	n/a	a	a	a	a	a	a	n/a	a	a	a	a	a	a	a	n/a	a	a	a	a	a	a	a
400x300 (eq. ø400)	632	1,5	2	21	--	--	40	37	27	-	-	-	42	28	26	19	-	-	-	31	24	22	-	-	-	-	27	
	1728	4,0	12	35	32	27	55	55	47	30	30	29	58	43	44	39	31	28	29	48	39	40	35	27	24	23	44	
	2592	6,0	26	34	31	27	55	54	46	37	35	32	58	43	44	38	31	29	31	47	39	40	34	27	25	25	43	
	3456	8,0	47	35	30	26	55	55	49	44	42	37	59	42	43	36	30	29	30	46	38	39	32	26	25	24	42	
	4467	10,3	77	39	33	28	60	58	55	51	49	44	63	47	44	36	31	34	35	49	43	40	32	27	30	29	45	
400x400 (eq. ø450)	804	1,4	2	21	--	--	40	37	27	-	-	-	42	29	27	20	-	-	-	31	25	23	-	-	-	-	27	
	2304	4,0	12	35	33	29	56	56	48	31	31	30	59	45	45	41	32	30	30	49	41	41	37	28	26	24	45	
	3456	6,0	26	33	32	28	56	56	47	37	36	33	59	44	45	39	32	30	32	48	40	41	35	28	26	26	44	
	4608	8,0	47	34	32	27	56	56	49	44	42	37	59	43	44	37	32	30	32	48	39	40	33	28	26	26	44	
	5685	9,9	70	37	33	29	60	58	54	50	47	43	63	47	45	37	32	34	35	50	43	41	33	28	30	29	46	
500x400 (eq. ø500)	1005	1,4	1	21	--	--	41	38	30	-	-	-	43	31	29	21	-	-	-	33	27	25	17	-	-	-	29	
	2880	4,0	12	36	34	30	57	56	51	34	33	32	60	47	47	42	33	31	31	51	43	43	38	29	27	25	47	
	4320	6,0	27	34	34	30	57	56	50	39	37	35	60	46	47	40	33	31	33	50	42	43	36	29	27	27	46	
	5760	8,0	48	34	33	29	57	56	51	46	43	39	60	45	46	39	33	31	33	49	41	42	35	29	27	27	45	
	7106	9,9	72	38	35	30	61	58	55	51	48	44	64	49	46	39	33	35	36	52	45	42	35	29	31	30	48	
600x400 (eq. ø560)	1206	1,4	2	18	--	--	43	36	19	-	-	-	44	32	30	22	-	-	-	35	28	26	18	-	-	-	31	
	3456	4,0	17	32	36	32	59	55	41	32	29	27	60	48	49	43	34	31	32	52	44	45	39	30	27	26	48	
	5184	6,0	38	32	35	31	59	55	46	43	40	35	61	48	49	42	34	32	34	52	44	45	38	30	28	28	48	
	6912	8,0	66	37	34	30	59	57	53	50	47	42	62	47	48	40	33	32	33	51	43	44	36	29	28	27	47	
	8528	9,9	98	41	36	31	64	61	59	56	53	48	67	51	48	40	34	36	37	53	47	44	36	30	32	31	49	
800x400 (eq. ø630)	1608	1,4	2	19	--	--	44	38	24	-	-	-	45	35	33	24	-	-	-	37	31	29	20	-	-	-	33	
	4608	4,0	17	33	38	34	60	57	46	33	31	31	62	51	51	45	35	33	33	55	47	47	41	31	29	27	51	
	6912	6,0	37	32	37	33	60	57	48	43	40	36	62	50	51	44	35	33	35	54	46	47	40	31	29	29	50	
	9216	8,0	65	36	36	32	60	58	54	50	47	42	63	49	50	42	35	33	35	53	45	46	38	31	29	29	49	
	11370	9,9	98	40	38	33	65	62	59	56	53	48	68	53	51	42	35	37	38	56	49	47	38	31	33	32	51	
1000x400 (eq. ø710)	2010	1,4	1	23	20	--	47	44	35	-	-	-	49	37	35	26	-	-	-	39	33	31	22	-	-	-	35	
	5760	4,0	12	38	39	35	63	62	56	36	35	35	66	53	53	47	36	34	34	57	49	49	43	32	30	28	53	
	8640	6,0	27	36	39	35	63	62	54	40	38	37	66	52	53	45	36	34	36	56	48	49	41	32	30	30	52	
	11520	8,0	48	35	38	34	62	61	54	46	43	40	65	51	52	44	36	34	36	55	47	48	40	32	30	30	51	
	14213	9,9	72	36	39	35	66	62	56	51	49	45	68	55	53	43	36	38	39	57	51	49	39	32	34	33	53	
1000x500 (eq. ø800)	2584	1,4	2	25	22	--	49	46	37	-	-	-	51	39	37	28	-	-	-	41	35	33	24	-	-	-	37	
	7200	4,0	12	39	41	37	65	64	57	37	36	36	68	55	55	48	37	35	35	59	51	51	44	33	31	29	55	
	10800	6,0	27	37	40	36	65	64	56	40	39	38	68	54	55	47	37	35	37	58	50	51	43	33	31	31	54	
	14400	8,0	48	35	39	35	64	63	55	46	44	40	67	53	54	45	37	35	37	57	49	50	41	33	31	31	53	
	18273	10,2	76	37	41	37	68	64	57	52	50	46	70	58	55	45	38	39	41	60	54	51	41	34	35	35	56	

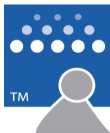

Drukval over unit : 200Pa

Unit afmeting equivalente diameter	Lucht volume (m ³ /h)	Luchtsnelheid (m/s)	Min. P _{st} (Pa)	snelselectie			Luchtgeluid VSQ-SW(DW)-SA						Afgestraald geluid VSQ-SW-SA					Afgestraald geluid VSQ-DW-SA										
				L _p (A) in dB(A)			Lw (dB/oct) re 10 ⁻¹² W						Lw (dB/oct) re 10 ⁻¹² W					Lw (dB/oct) re 10 ⁻¹² W										
				Luchtgeluid	Afgestraald geluid enkelwandig	Afgestraald geluid dubbelwandig	125 Hz	250 Hz	500 Hz	1000 Hz	2000 Hz	4000 Hz	L _w (A) dB(A)	125 Hz	250 Hz	500 Hz	1000 Hz	2000 Hz	4000 Hz	L _w (A) dB(A)	125 Hz	250 Hz	500 Hz	1000 Hz	2000 Hz	4000 Hz	L _w (A) dB(A)	
300x300 (eq. ø355)	486	1,5	2	--	--	--	37	29	-	-	-	-	-	37	26	23	-	-	-	-	28	22	19	-	-	-	-	24
	1296	4,0	17	33	33	28	55	51	39	32	29	26	56	44	45	41	33	29	30	48	40	41	37	29	25	24	44	
	1944	6,0	38	40	42	38	62	60	49	43	40	36	64	51	53	50	45	39	40	57	47	49	46	41	35	34	53	
	2592	8,0	66	42	41	36	61	60	54	50	47	43	64	50	52	48	43	38	40	55	46	48	44	39	34	34	51	
	3350	10,3	108	46	40	35	63	63	60	57	54	49	68	49	51	45	42	38	40	54	45	47	41	38	34	34	50	
400x300 (eq. ø400)	632	1,5	2	19	--	--	38	34	24	-	-	-	39	26	24	-	-	-	28	22	20	-	-	-	-	-	24	
	1728	4,0	12	38	34	30	57	56	49	32	32	31	60	45	46	42	34	31	31	50	41	42	38	30	27	25	46	
	2592	6,0	26	45	44	39	64	65	59	44	42	41	68	52	55	51	46	41	41	58	48	51	47	42	37	35	54	
	3456	8,0	47	42	42	38	63	64	57	46	44	42	67	51	53	49	45	40	41	57	47	49	45	41	36	35	53	
	4467	10,3	77	42	41	37	62	63	57	52	49	45	67	50	52	47	43	39	41	55	46	48	43	39	35	35	51	
400x400 (eq. ø450)	804	1,4	2	41	34	30	57	56	51	29	28	25	60	45	46	43	31	27	26	50	41	42	39	27	23	20	46	
	2304	4,0	12	37	35	31	58	58	51	33	33	32	61	46	47	43	35	32	32	51	42	43	39	31	28	26	47	
	3456	6,0	26	45	45	41	65	66	60	46	43	42	69	54	56	53	47	42	43	59	50	52	49	43	38	37	55	
	4608	8,0	47	42	43	39	64	65	58	47	45	43	68	52	54	50	46	41	42	58	48	50	46	42	37	36	54	
	5685	9,9	70	41	42	38	63	64	58	51	48	45	68	51	53	48	45	41	42	57	47	49	44	41	37	36	53	
500x400 (eq. ø500)	1005	1,4	1	42	35	31	57	56	54	31	30	27	61	47	47	45	32	28	27	51	43	43	41	28	24	21	47	
	2880	4,0	12	38	37	32	59	58	54	36	35	34	62	48	49	45	36	33	33	53	44	45	41	32	29	27	49	
	4320	6,0	27	46	46	42	66	67	63	48	45	44	70	56	58	54	48	43	44	61	52	54	50	44	39	38	57	
	5760	8,0	48	43	45	40	65	65	61	49	46	45	69	54	56	52	47	42	43	60	50	52	48	43	38	37	56	
	7106	9,9	72	42	44	39	64	65	60	52	49	46	68	53	55	50	46	41	43	59	49	51	46	42	37	37	55	
600x400 (eq. ø560)	1206	1,4	2	36	37	33	59	55	43	-	-	19	61	49	49	46	33	29	28	53	45	45	42	29	25	22	49	
	3456	4,0	17	34	38	34	61	57	43	32	30	28	62	50	51	46	37	34	34	54	46	47	42	33	30	28	50	
	5184	6,0	38	40	47	43	68	65	53	43	40	38	70	57	59	55	49	44	44	63	53	55	51	45	40	38	59	
	6912	8,0	66	40	46	42	67	64	55	50	48	43	69	56	58	53	48	43	44	61	52	54	49	44	39	38	57	
	8528	9,9	98	42	45	41	67	65	59	56	53	48	70	55	57	51	47	42	44	60	51	53	47	43	38	38	56	
800x400 (eq. ø630)	1608	1,4	2	38	39	35	61	57	48	25	25	26	62	51	52	48	34	30	29	55	47	48	44	30	26	23	51	
	4608	4,0	17	35	40	36	62	59	48	33	33	33	64	52	53	48	38	35	35	57	48	49	44	34	31	29	53	
	6912	6,0	37	42	49	45	69	67	58	45	43	43	72	60	62	57	50	45	46	65	56	58	53	46	41	40	61	
	9216	8,0	65	40	48	44	68	66	57	51	48	45	71	58	60	55	49	44	45	63	54	56	51	45	40	39	59	
	11370	9,9	98	41	47	42	68	66	60	56	53	49	71	57	59	53	48	44	45	62	53	55	49	44	40	39	58	
1000x400 (eq. ø710)	2010	1,4	1	44	40	36	63	62	59	34	33	30	67	53	53	50	35	31	30	57	49	49	46	31	27	24	53	
	5760	4,0	12	40	42	37	65	64	58	39	37	37	68	54	55	49	39	36	36	59	50	51	45	35	32	30	55	
	8640	6,0	27	48	51	47	72	73	68	51	47	47	76	62	64	59	51	46	47	67	58	60	55	47	42	41	63	
	11520	8,0	48	45	49	45	71	71	65	50	48	47	75	60	62	56	50	45	46	65	56	58	52	46	41	40	61	
	14213	9,9	72	43	48	44	70	70	64	53	50	48	74	59	61	55	49	44	46	64	55	57	51	45	40	40	60	
1000x500 (eq. ø800)	2584	1,4	2	46	43	39	66	65	61	36	34	32	69	56	56	52	37	33	32	60	52	52	48	33	29	26	56	
	7200	4,0	12	41	43	39	67	66	60	39	38	38	70	56	57	51	40	37	37	60	52	53	47	36	33	31	56	
	10800	6,0	27	48	53	48	74	75	69	52	48	48	78	64	66	61	52	47	48	69	60	62	57	48	43	42	65	
	14400	8,0	48	45	51	47	73	73	67	51	49	48	76	62	64	58	51	46	47	67	58	60	54	47	42	41	63	
	18273	10,2	76	43	50	45	72	72	65	53	51	49	76	61	63	56	50	45	47	66	57	59	52	46	41	41	62	

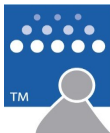

Drukval over unit : 400Pa

Unit afmeting equivalente diameter	Lucht volume (m ³ /h)	Luchtsnelheid (m/s)	Min. P _{st} (Pa)	snelselectie			Luchtgeluid VSQ-SW(DW)-SA						Afgestraald geluid VSQ-SW-SA					Afgestraald geluid VSQ-DW-SA									
				L _p (A) in dB(A)			Lw (dB/oct) re 10 ⁻¹² W						Lw (dB/oct) re 10 ⁻¹² W					Lw (dB/oct) re 10 ⁻¹² W									
				Luchtgeluid	Afgestraald geluid enkelwandig	Afgestraald geluid dubbelwandig	125 Hz	250 Hz	500 Hz	1000 Hz	2000 Hz	4000 Hz	L _w (A) dB(A)	125 Hz	250 Hz	500 Hz	1000 Hz	2000 Hz	4000 Hz	L _w (A) dB(A)	125 Hz	250 Hz	500 Hz	1000 Hz	2000 Hz	4000 Hz	L _w (A) dB(A)
300x300 (eq. ø355)	486	1,5	2	39	36	32	57	53	42	18	17	19	58	46	47	46	34	29	28	51	42	43	42	30	25	22	47
	1296	4,0	17	35	36	32	57	54	42	32	29	27	59	47	48	44	37	33	33	52	43	44	40	33	29	27	48
	1944	6,0	38	41	44	40	63	61	50	43	40	37	66	53	55	52	47	41	42	59	49	51	48	43	37	36	55
	2592	8,0	66	46	52	48	68	67	57	51	48	44	71	58	61	59	56	48	49	65	54	57	55	52	44	43	61
	3350	10,3	108	48	52	48	69	68	61	57	54	50	72	58	61	59	57	49	50	65	54	57	55	53	45	44	61
400x300 (eq. ø400)	632	1,5	2	46	37	33	59	59	55	33	31	28	63	47	48	47	36	30	29	53	43	44	43	32	26	23	49
	1728	4,0	12	41	37	33	59	60	53	36	35	34	63	48	49	46	38	34	34	53	44	45	42	34	30	28	49
	2592	6,0	26	47	46	42	65	67	61	47	44	43	70	54	56	54	49	42	43	60	50	52	50	45	38	37	56
	3456	8,0	47	52	53	49	71	73	68	55	51	50	76	59	62	60	57	50	50	66	55	58	56	53	46	44	62
	4467	10,3	77	51	53	49	71	73	68	57	53	52	76	59	62	60	58	50	52	66	55	58	56	54	46	46	62
400x400 (eq. ø450)	804	1,4	2	46	39	35	60	60	57	35	32	30	64	49	50	49	37	32	30	54	45	46	45	33	28	24	50
	2304	4,0	12	41	39	35	61	61	55	37	36	35	64	49	51	47	40	35	36	54	45	47	43	36	31	30	50
	3456	6,0	26	47	47	43	67	68	63	48	45	44	71	55	58	55	50	44	44	61	51	54	51	46	40	38	57
	4608	8,0	47	52	54	50	72	74	69	56	52	51	77	60	64	62	59	51	52	68	56	60	58	55	47	46	64
	5685	9,9	70	51	54	50	72	74	69	57	53	52	77	60	64	61	59	51	53	68	56	60	57	55	47	47	64
500x400 (eq. ø500)	1005	1,4	1	47	40	36	61	61	59	37	34	32	65	51	52	50	38	33	31	56	47	48	46	34	29	25	52
	2880	4,0	12	42	40	36	61	61	57	40	38	37	65	51	52	49	41	36	36	56	47	48	45	37	32	30	52
	4320	6,0	27	48	48	44	67	68	65	50	46	46	72	57	59	56	51	45	45	63	53	55	52	47	41	39	59
	5760	8,0	48	53	56	51	73	74	72	59	54	53	78	62	65	63	60	52	53	69	58	61	59	56	48	47	65
	7106	9,9	72	52	56	52	73	75	72	60	55	54	78	62	66	63	60	52	54	69	58	62	59	56	48	48	65
600x400 (eq. ø560)	1206	1,4	2	41	42	38	63	59	48	22	21	24	65	52	53	52	39	33	32	57	48	49	48	35	29	26	53
	3456	4,0	17	37	41	37	63	60	46	32	30	30	65	53	54	50	41	37	37	57	49	50	46	37	33	31	53
	5184	6,0	38	42	50	45	69	67	55	43	41	39	71	59	61	58	52	45	46	64	55	57	54	48	41	40	60
	6912	8,0	66	47	57	53	74	73	61	51	48	47	77	64	67	64	60	53	53	71	60	63	60	56	49	47	67
	8528	9,9	98	47	57	53	75	74	63	56	53	50	77	64	67	64	61	53	54	71	60	63	60	57	49	48	67
800x400 (eq. ø630)	1608	1,4	2	43	44	40	64	61	54	31	30	30	66	55	56	54	40	35	33	60	51	52	50	36	31	27	56
	4608	4,0	17	38	44	39	65	62	52	35	35	36	67	55	57	52	43	38	39	60	51	53	48	39	34	33	56
	6912	6,0	37	43	51	47	71	69	60	46	44	44	73	61	64	60	53	47	47	67	57	60	56	49	43	41	63
	9216	8,0	65	48	58	54	76	75	67	54	51	52	79	66	70	66	62	54	55	73	62	66	62	58	50	49	69
	11370	9,9	98	48	59	55	76	75	67	58	55	54	79	66	70	66	62	55	56	73	62	66	62	58	51	50	69
1000x400 (eq. ø710)	2010	1,4	1	49	45	41	67	67	64	40	37	35	71	57	58	55	41	36	34	61	53	54	51	37	32	28	57
	5760	4,0	12	44	45	41	67	67	62	43	41	40	71	57	58	53	44	39	40	62	53	54	49	40	35	34	58
	8640	6,0	27	50	53	49	73	74	70	53	49	49	78	63	65	61	54	48	48	69	59	61	57	50	44	42	65
	11520	8,0	48	55	60	56	79	80	77	62	56	56	84	68	71	68	63	55	56	75	64	67	64	59	51	50	71
	14213	9,9	72	54	60	56	79	81	77	63	57	57	84	68	72	68	63	55	57	75	64	68	64	59	51	51	71
1000x500 (eq. ø800)	2584	1,4	2	50	47	43	69	68	65	41	38	36	73	58	59	56	42	37	35	63	54	55	52	38	33	29	59
	7200	4,0	12	45	47	43	69	69	64	44	42	41	73	59	60	55	45	40	40	64	55	56	51	41	36	34	60
	10800	6,0	27	50	55	50	75	76	72	54	50	50	80	65	67	63	55	49	49	70	61	63	59	51	45	43	66
	14400	8,0	48	56	61	57	80	82	78	63	57	57	86	70	73	70	64	56	56	76	66	69	66	60	52	50	72
	18273	10,2	76	55	62	57	81	83	78	64	59	58	86	70	74	69	64	57	58	77	66	70	65	60	53	52	73

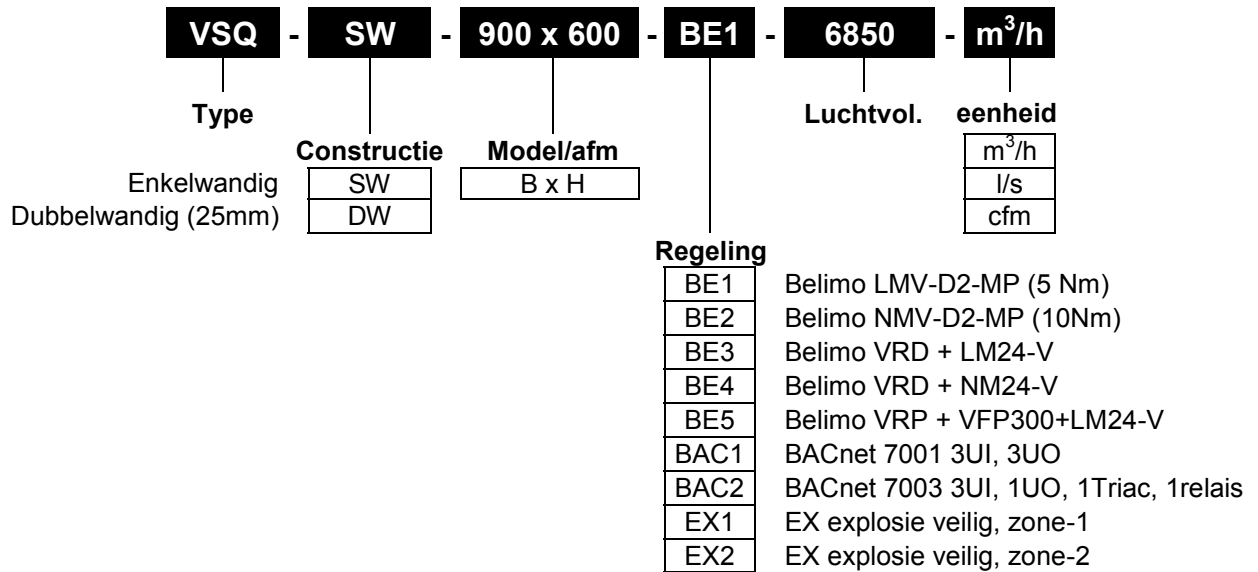
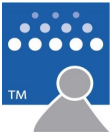

Besteksomschrijving:

Voorbeeld:

Leveren en monteren rechthoekige dubbelwandige VAV unit vervaardigd uit 1.2mm gegalvaniseerd plaatstaal, met 30mm kanaalflenzen. Luchtdichtheid Luka klasse B. Geprofileerde gegalvaniseerd stalen klepbladen, 100m, ABS tandwielen en een aluminium aandrijfjas 10x10mm of ø12mm. De unit is voorzien van 1 of meerdere (afhankelijk van unit hoogte) mid-delende en snelheidsdruk versterkende luchtsnelheidsensoren type FloXact®.

Voor:

Luchtvolume (Vmax) m ³ /h
Unit afmeting (bxh) x mm
Max. drukval Pa
Max. luchtgeluid dB(A)
Max. afgestraaldgeluid dB(A)
Regelaar	BACnet type 7003, inclusief fabriekskalibratie en montage.
Fabrikaat	AIR-CONCEPTS BV
Type	VSQ-DW-xxx-BAC1-xxx-

AIR-CONCEPTS BV

De Corantijn 97, 1689AN Hoorn
Postbus 3099, 1620 GB Hoorn
T +31 229 262 300
F +31 229 263 182
E info@air-concepts.nl
W www.air-concepts.nl