

Fan powered VAV terminals Series type



AIRFLOW MEASUREMENT AND CONTROL

Application

Series fan VAV terminals type VFS mix primary air and induced air and provide a constant air supply to the room. This results in excellent air distribution even with high turn-down of the primary air volume. Mixing between the primary air and induced air is by forward curved centrifugal fan with direct drive EC motor. This ensures low energy consumption, low noise and easy to control with a 0-10VDC signal.

AIR-CONCEPTS VFS terminals have been designed to achieve low noise levels. Discharge and case radiated sound pressure levels of NR 32 can be achieved in the occupied zone.

Pressure independent control of the primary VAV damper is accomplished by use of a multi-point averaging air flow sensor type FloXact™, which gives accurate control of air flow even with a 90° bend on the inlet spigot. The VFS terminals are suitable for low (<10°C) primary air temperature applications.

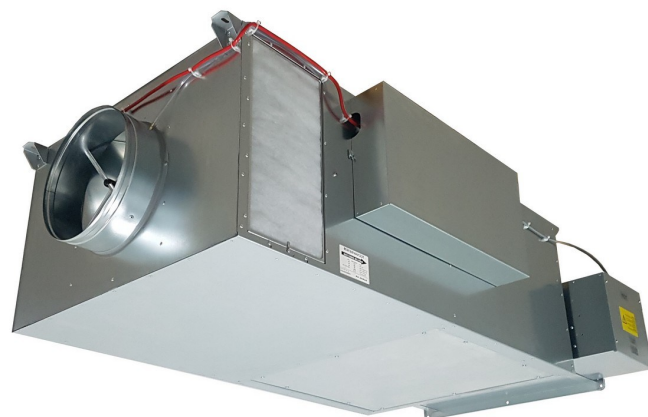

Type VFS-model 3, inlet 315mm

Design features

Casing

- Ridged galvanised steel construction (1,0mm or 20 gauge).
- Spigots comply with DIN 24145 or DIN 24146.
- Oval shaped damper blade, sandwich construction with synthetic rubber seals. Leakage rate 0.25% of Vnom @ 750Pa (3" WG) static pressure drop.
- Air leakage flow complies with Class II, VDI 3803 or DIN 24194, Part 2
- Damper shaft aluminium, ø12 mm
- Bearings Polyamide (PA6.6)
- Thermal / acoustical insulation 25kg/m3 (1,5lb/cuFt) non-fibrous or fiberglass, fire resistant to BS-476 Class "O". Exposed edges are sealed from the air-stream with solid metal lining.
- Operating temperature +5 to 50°C
- Storage temperature 0 to +70°C, max R.H. 95%
- Other construction available upon request.

Air flow sensor

- The unique shape, patent pending, creates a linear amplified signal (at least 2.5x P_{dyn}) with a very low pressure drop and noise level.
- Multi point averaging according to the "Log-Tchebycheff" method
- 1% accuracy with 3xD straight duct approach
- 5% accuracy with 1xD straight duct approach
- Stable measuring signal from 0,7 m/s air velocity



Type SA-3 sound attenuator

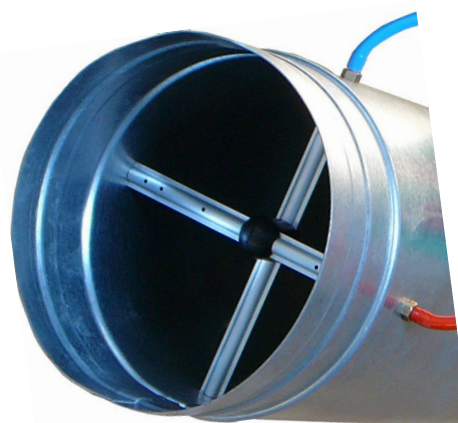

Detail FloXact-X® multipoint, averaging air flow sensor

Kv Values FloXact-X®

	units	125	160	200	250	315
Kv Value	l/s/Pa	8,89	15,6	25,5	41,3	67,5
	m3/h/Pa	32,0	56,2	91,9	148,8	243,0
Vnom @ 150Pa	l/s	109	191	313	506	827
	m3/h	392	688	1.125	1.822	2.976
Vnom @ 250Pa (1" WC)	l/s	141	247	404	653	1.067
	m3/h	506	888	1.453	2.352	3.842

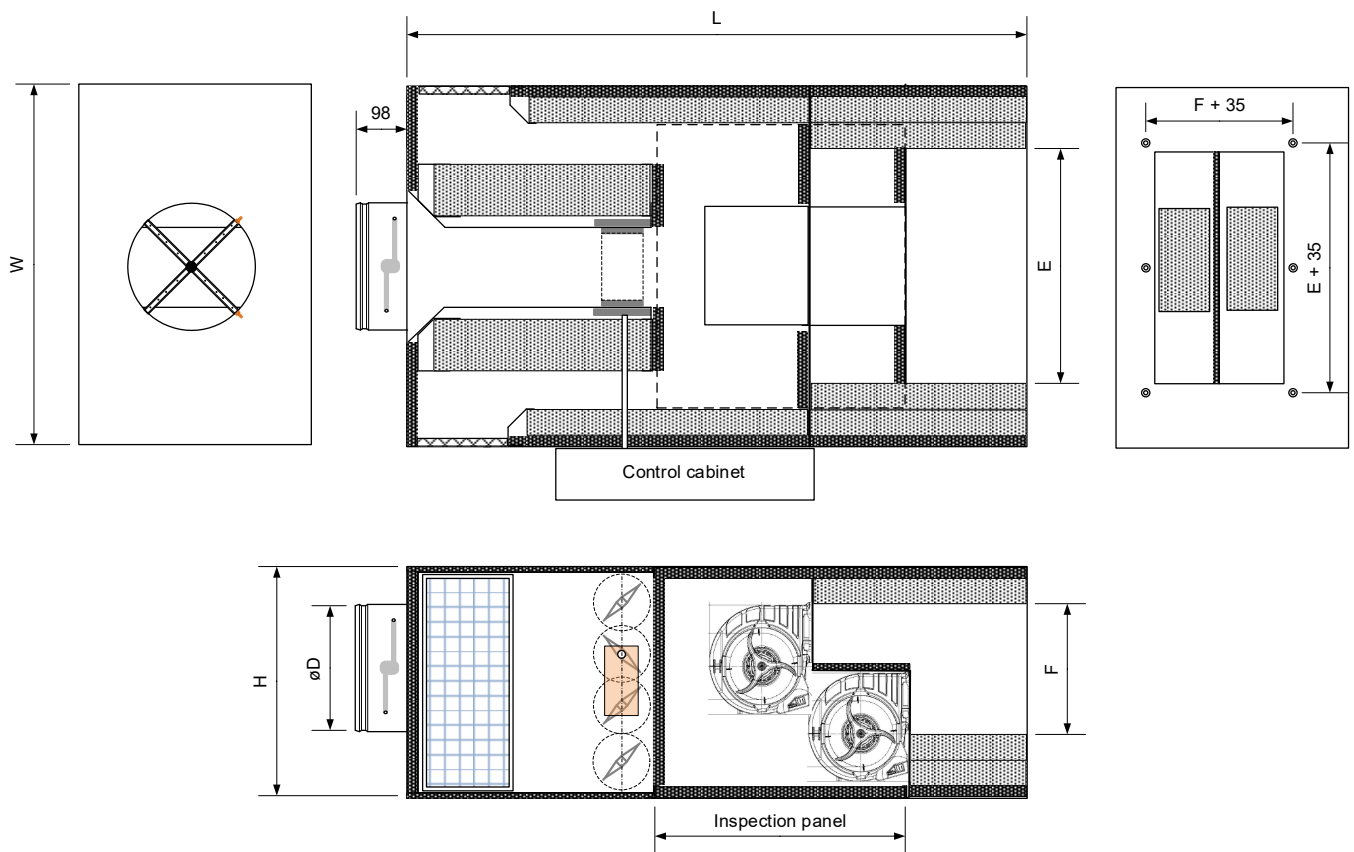
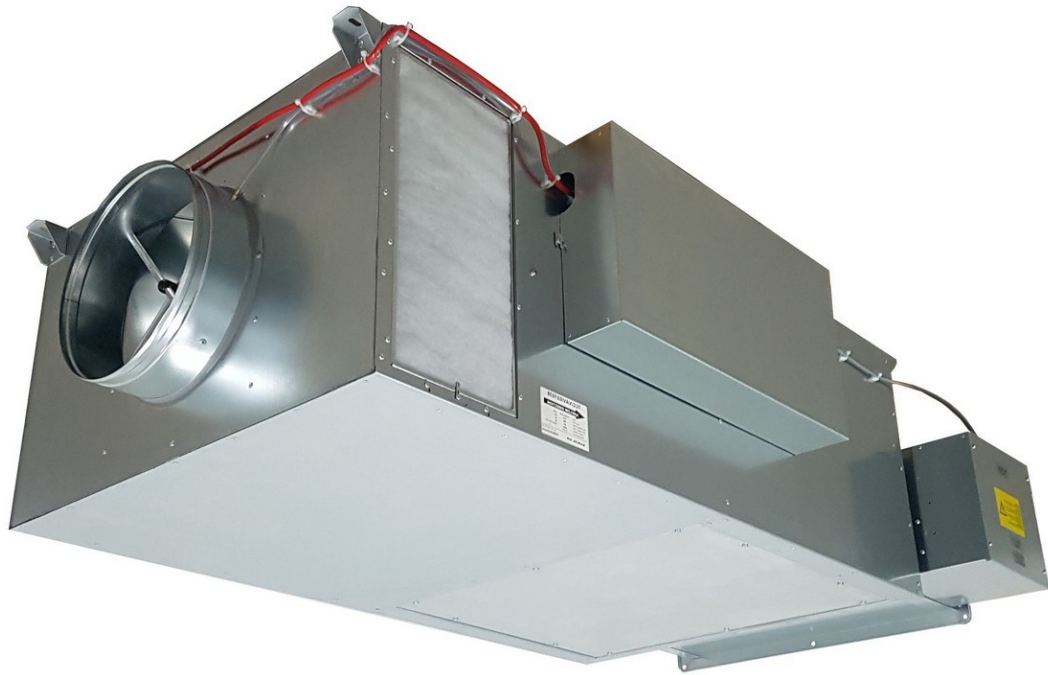

Dimensions and weight (without controls)

Unit size	ϕD	W	H	L	E	F	Kg
1	123, 158, 198	550	350	1000	350	200	55
2	158, 198, 248	700	450	1200	450	250	85
3	198, 248, 312	1000	450	1200	750	250	120



Type SA (sound attenuator)

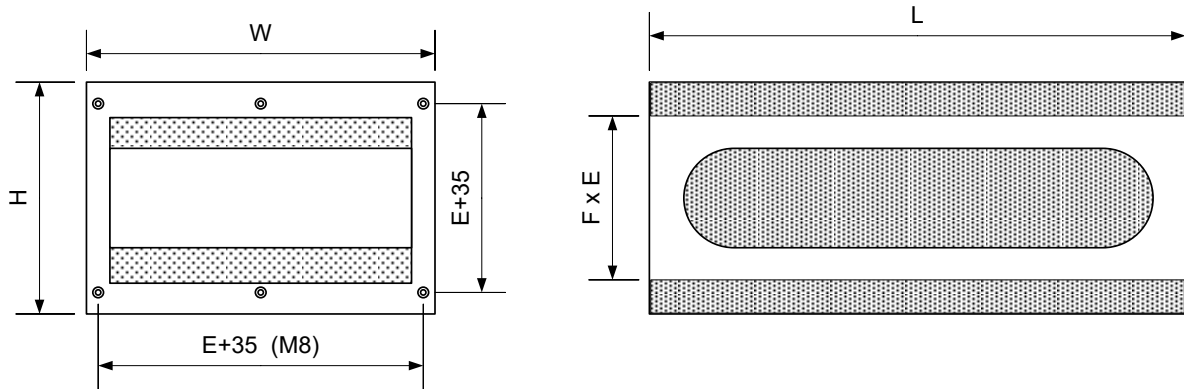

Type SA (sound attenuator)

Dimensions and weight

Unit size	W	H	L	E	F	Kg
1	310	260	600	250	200	
2	510	310	800	450	250	
3	810	310	1200	750	250	



Sound data NR

1. The discharge sound pressure levels **Lp(A)**, are determined with a room absorption of 7dB/oct and the following assumption for downstream ductwork, diffuser(s) and end reflection:

125	250	500	1k	2k	4k	Hz
-3	-5	-10	-15	-15	-12	dB

2. The discharge sound pressure levels **Lp(A)** also include a correction for air volume :

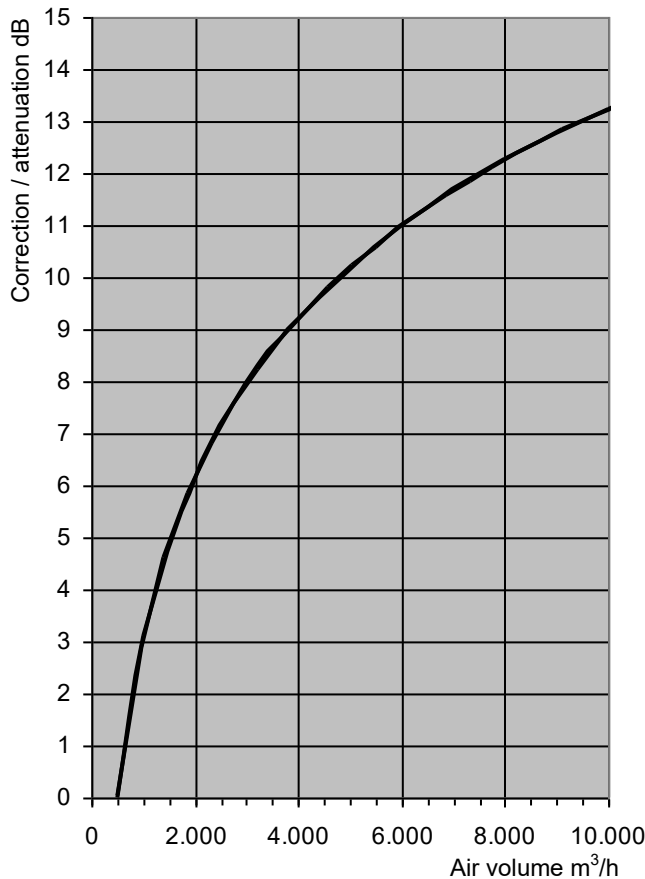

3. The radiated sound pressure levels **Lp(A)** are determined with a room absorption of 7dB/oct and the following assumption ceiling attenuation:

125	250	500	1k	2k	4k	Hz
-1	-3	-5	-7	-7	-10	dB

4. Sound data is measured in a reverberation room at an independent sound laboratory, according to ISO-3741 and ISO-5135 standards.
5. L_w in dB/Oct are sound power levels (re $10^{-12}W$) per octave band in dB for discharge sound and radiated sound. Values less than 17 dB are indicated by "-".
6. **n/a** Not applicable, static pressure < unit resistance
7. **min ΔPs.** Unit resistance with fully opened damper blade

Model (Fan)	Air Volume (Fan)		Discharge sound (Duct borne sound)										Radiated sound (Break out sound)							
			Lw (dB/oct) re 10 ⁻¹² W							Quick Sel. L _p			Lw (dB/oct) re 10 ⁻¹² W							Quick Sel. L _p
	mm	m ³ /h	l/s	125 Hz	250 Hz	500 Hz	1k Hz	2k Hz	4k Hz	Lw dB	NR ₁	NR ₂	NR ₃	125 Hz	250 Hz	500 Hz	1k Hz	2k Hz	4k Hz	Lw dB
1	180	50	49	48	41	33	26	26	52	38	26	19	27	26	20	19	13	13	30	19
	270	75	49	48	41	33	26	26	52	39	27	20	27	26	20	19	13	13	31	19
	360	100	50	49	42	34	27	27	53	40	28	21	28	27	21	20	14	14	32	20
	450	125	51	50	43	35	28	28	54	41	29	22	29	28	22	21	15	15	33	21
	540	150	52	51	44	36	29	29	55	42	30	22	30	29	23	22	16	16	34	22
	630	175	53	52	45	37	30	30	56	42	30	23	31	30	24	23	17	17	35	23
	720	200	55	54	47	39	32	32	58	43	31	24	33	32	26	25	19	19	36	25
2	360	100	50	49	42	34	27	27	53	40	28	19	28	27	21	20	14	14	32	20
	540	150	52	51	44	36	29	29	55	42	30	20	30	29	23	22	16	16	34	22
	720	200	54	53	46	38	31	31	57	42	30	21	32	31	25	24	18	18	35	24
	900	250	56	55	48	40	33	33	59	43	31	22	34	33	27	26	20	20	37	26
	1080	300	58	57	50	42	35	35	61	45	33	24	36	35	29	28	22	22	39	28
	1260	350	60	59	52	44	37	37	63	46	34	25	38	37	31	30	24	24	41	30
	1440	400	61	60	53	45	38	38	64	47	35	26	39	38	32	31	25	25	43	31
3	900	250	56	55	48	40	33	33	59	43	31	23	32	31	28	26	20	20	36	24
	1080	300	58	57	50	42	35	35	61	45	33	24	34	33	30	28	22	22	38	26
	1260	350	60	59	52	44	37	37	63	46	34	26	36	35	32	30	24	24	40	28
	1440	400	61	60	53	45	38	38	64	47	35	27	37	36	33	31	25	25	41	29
	1620	450	63	62	55	47	40	40	66	48	36	28	39	38	35	33	27	27	43	31
	1800	500	64	63	56	48	41	41	67	50	38	30	40	39	36	34	28	28	44	32
	1980	550	66	65	58	50	43	43	69	51	39	31	42	41	38	36	30	30	46	34
	2160	600	67	66	59	51	44	44	70	52	40	32	43	42	39	37	31	31	47	35
	2340	650	68	67	60	52	45	45	71	53	41	33	44	43	40	38	32	32	48	36
	2520	700	69	68	61	53	46	46	72	54	42	34	45	44	41	39	33	33	50	37
	2700	750	71	70	63	55	48	48	74	54	42	35	47	46	43	41	35	35	51	39
	2880	800	72	71	64	56	49	49	75	55	43	36	48	47	44	42	36	36	52	40

Sound data NR

- NR₁ NR rating of sound power levels for duct borne generated noise at the outlet of the terminal.
- NR₂ NR rating of sound pressure levels for duct borne generated noise including the insertion loss for downstream duct, diffuser(s) and end reflection as specified on page 3.
- NR₃ NR rating of sound pressure levels for duct borne generated noise including the insertion loss for a sound attenuator type (SA) downstream duct, diffuser(s) and end reflection as specified on page 3.
- NR₄ NR rating of sound pressure levels for radiated noise including ceiling attenuation and room absorption as specified on page 3.

Specification :

Fan motor	: External rotor, brushless DC
Fan type	: forward curved, dual inlet
Nominal running speed	: 1450 r/min
Supply voltage	: 207...253 VAC 50/60Hz
Speed control voltage	: 1,0...9,5VDC for 10...100%
Speed control PWM	: 10...95% for 10...100%
Protection	: IP20
Operating / storage	: -25...+60°C, 5...95% RH.
Certification	: CE + EN60355-1 (Household and similar applications)
RoHS compliance	: Yes
Internal fuse	: 4,5 A @ 230VAC
Soft start function	: 20 seconds to reach full speed
Scroll housing	: galvanised steel
Impeller	: galvanised steel
Life expectancy	: 40.000 hrs (> 12 years office hours)

Electrical connections / wiring

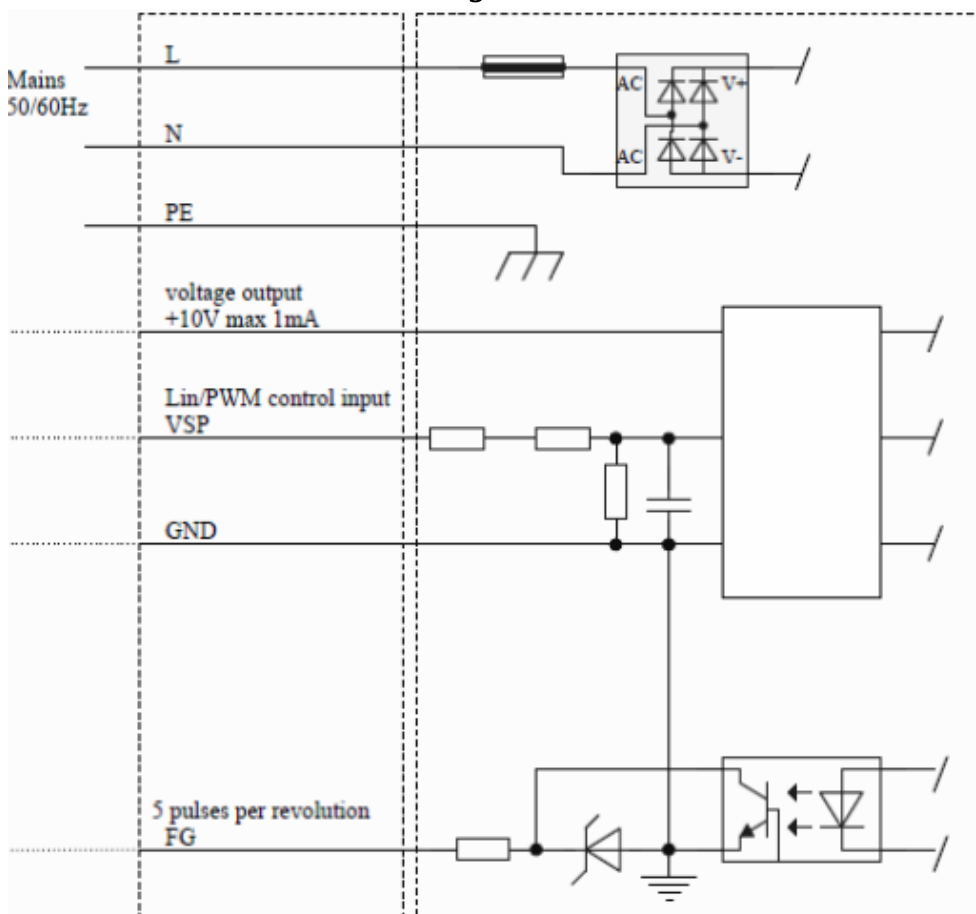

Fan motor details (EC type)

Unit size	Airflow (l/s) max at 150Pa ext.	n ⁻¹ (max)	W At max	Kg
1	240	1450	135	2,7
2	475	1450	275	5,4
3	950	1450	550	10,7

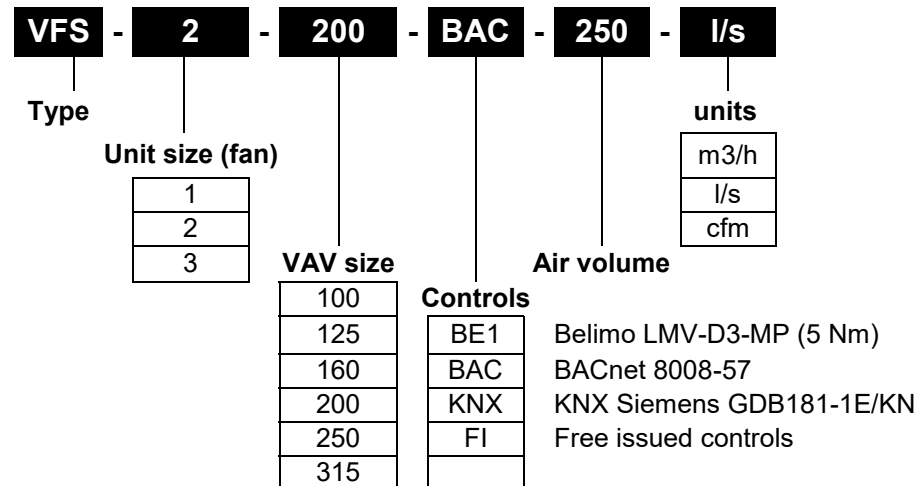

Specify as:

Example:

Supply and install, Fan powered VAV terminal, from galvanized sheet steel, duct sleeve connection suitable for DIN 24 145 or DIN 24 146. Casing leakage rate to class II, VDI 3803/ DIN 24 194. The primary air inlet VAV should have a low leakage, sandwich construction damper blade with SBR gasket and an aluminium damper shaft with self lubricating Nylon bearings and averaging airflow sensor type FloXact®.

Direct drive forward curved fan with EC motor.

For:

Air volume	l/s
Primary inlet	mm
Max. pressure loss	Pa
Max. discharge SPL	NR
Max. radiated SPL	NR
Controller	BACnet type 8008-57 (factory programmed, fitted and calibrated)	
Manufacturer	AIR-CONCEPTS B.V.	
Origin	Slovenia / EU	
Type	VFS-xxx-BAC-xxx-	

Delivery / Controls

- All controls fitted are pressure independent and factory calibrated.
- The unit can be supplied with analogue, DDC or pneumatic controls
- When units are ordered with controls "free-issued" by 3rd party, wiring diagrams, calibration instructions, calibration tools and mounting instructions must be provided free of charge.
- All controls will be mounted, as standard, on the right hand side of the unit when looking in the direction of airflow, unless otherwise requested.

AIR-CONCEPTS B.V.

De Compagnie 22E+F
 1689AG Hoorn (NL)
 +31 229 262 300
 info@air-concepts.nl
 www.air-concepts.nl



1 & 2 Stephen Street, London